

MX20 Quick Reference Guide

1. Turn the power on. The screen will remain dark for a short time while the MX20 performs preheat and self-test operations.
2. Adjust the brightness, if necessary.
3. Check that all tests pass on the Start Up screen.
4. Press the **FN** key to view available functions.
Each press of the **FN** key will step through the lists of functions.
5. Press the "smart" key below the function label to select the desired function. Press the **FN** key again to view functions. See Figure A.
6. Once a function is selected, the function labels change to give options for that function. Press the "smart" keys below the labels to choose options. See Figure B.
7. Once a function is selected, the **Menu/Enter** key is used to give additional options.
8. Press the **Line Select** key next to the displayed option to choose desired capabilities. Some options use multiple key presses for different states for the option. Press the **Menu/Enter** key again to extinguish the option display. See Figure C.
9. Refer to the Detailed Operation section of the User's Guide for more details on each function.

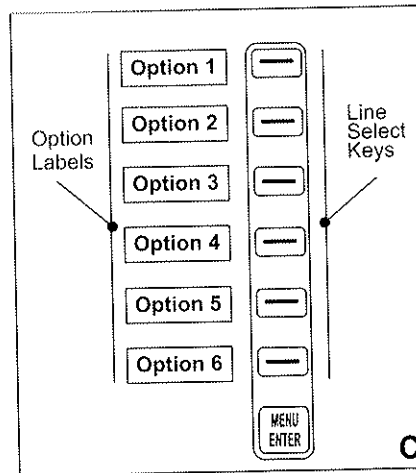
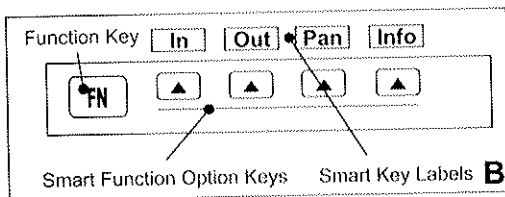
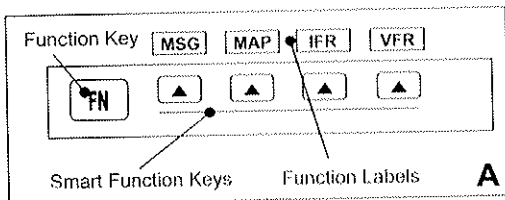

 **UPS Aviation Technologies**
A subsidiary of United Parcel Service

P/N 561-0263-00
January 2000

2345 Turner Rd., S.E.
Salem, OR 97302

FAX (503) 364-2138
<http://www.upsat.com>

USA 800-525-6726
Canada 800-654-3415
International (503) 391-3411

© 2000 by UPS Aviation
Technologies, Inc.
Printed in the U.S.A.
All Rights Reserved

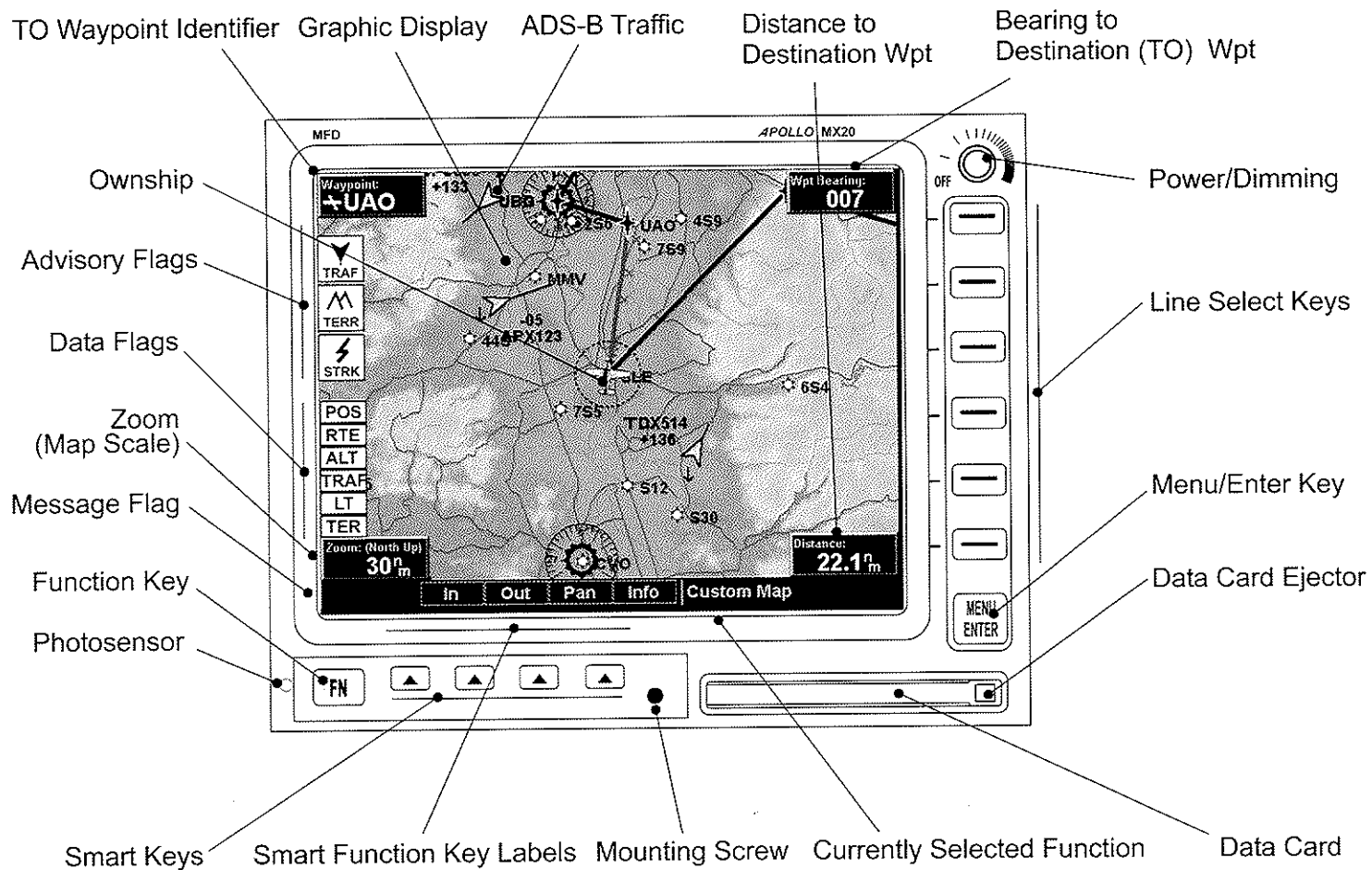

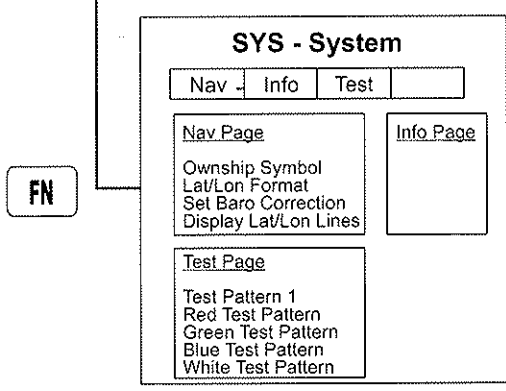
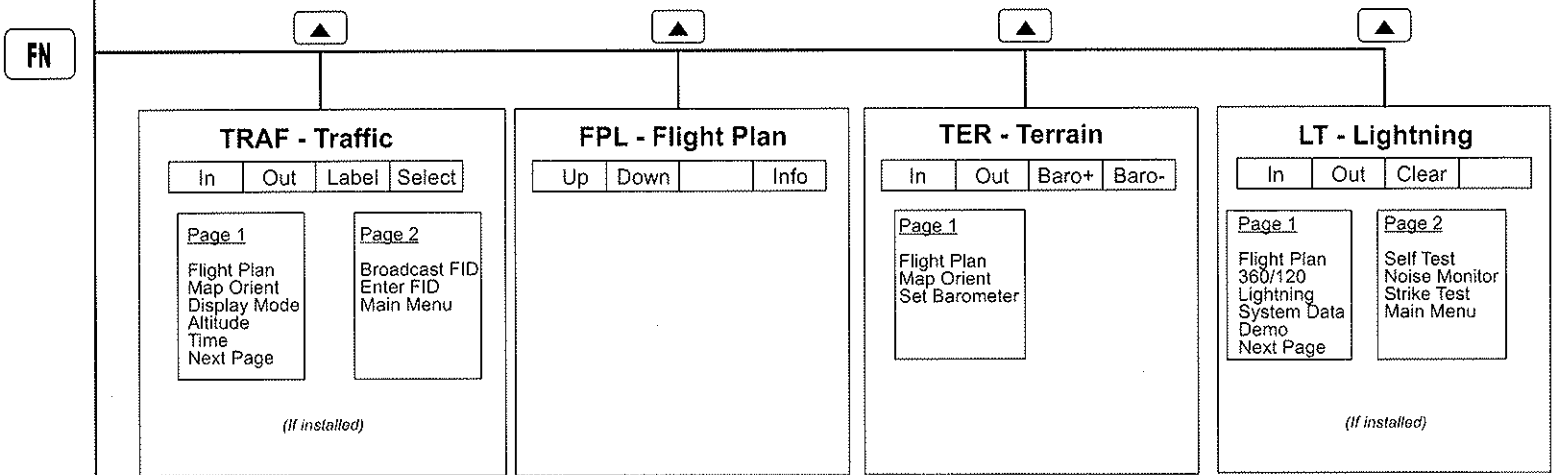
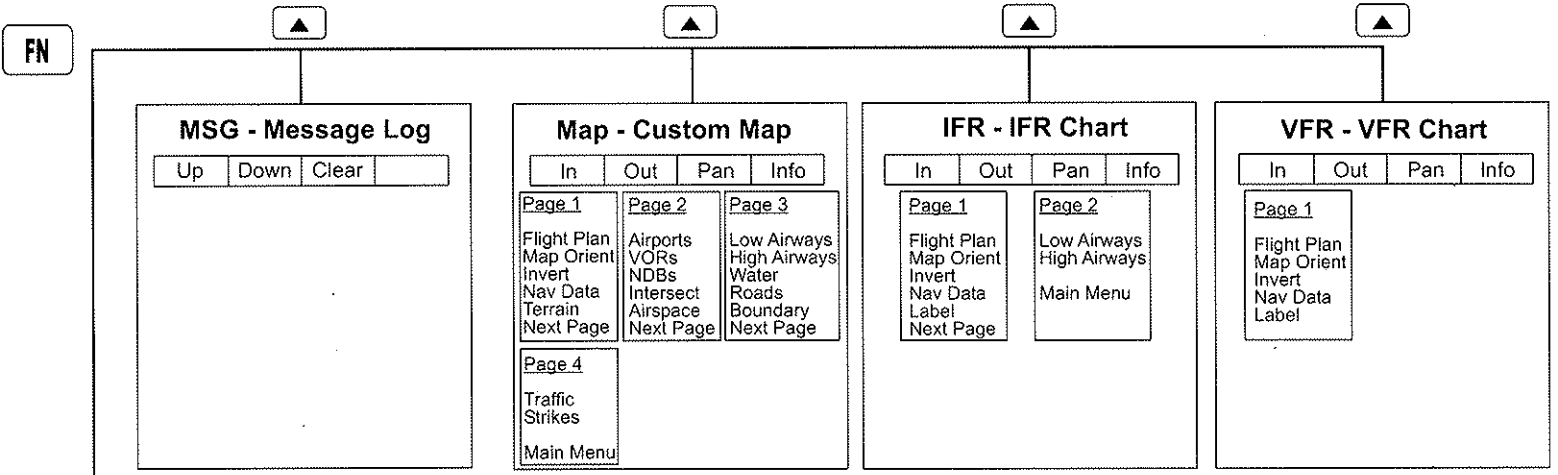

Terrain Color Key

Red	Terrain that is at, or above, your current altitude
Yellow	Terrain that is within 500 ft of your current altitude.
Green	Terrain that is within 2000 ft of your current altitude.
Black	Terrain that is more than 2000 ft below your current altitude.
Light Blue	No terrain data is available.

